

PIANTA INGOMBRI

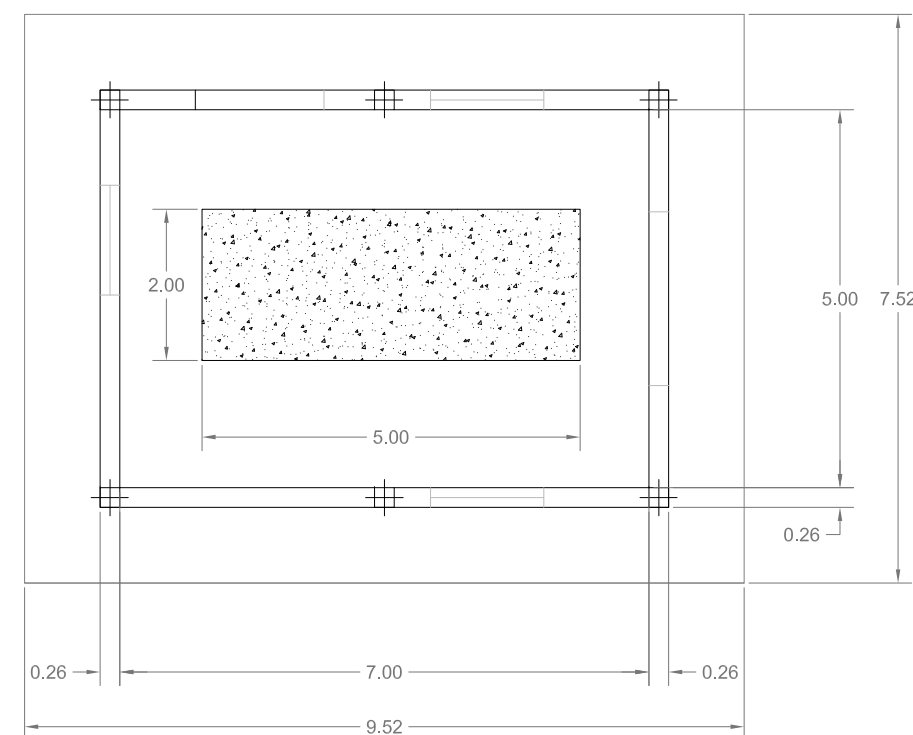

SEZIONE A-A

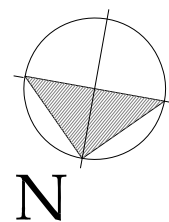
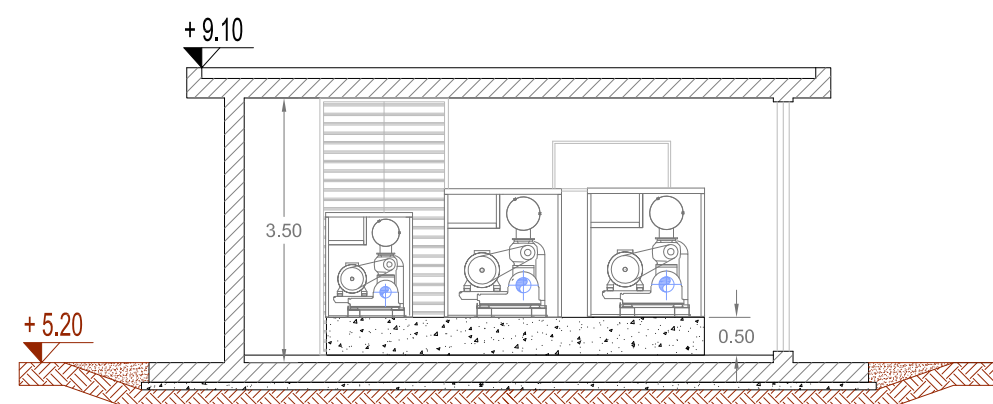

PIANTA ELETTROMECCANICA E PIPING

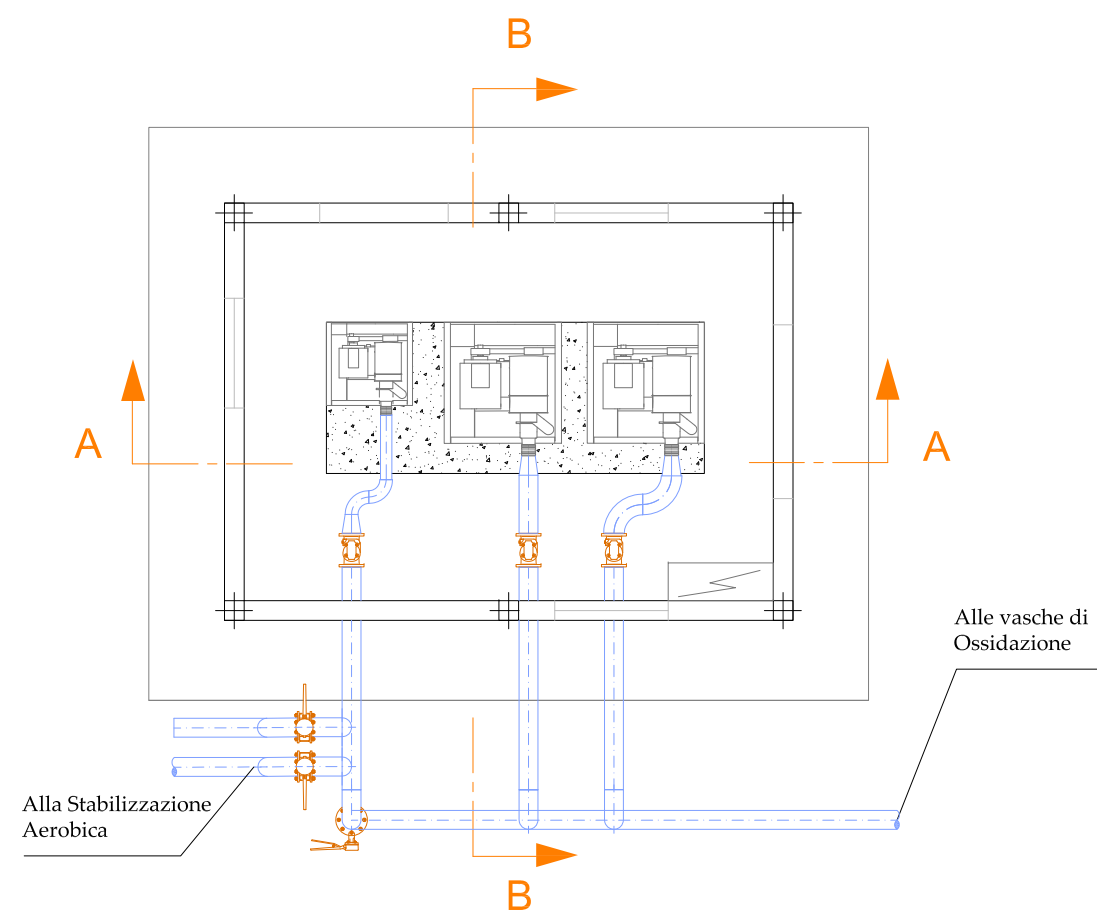
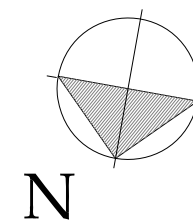

SEZIONE B-B

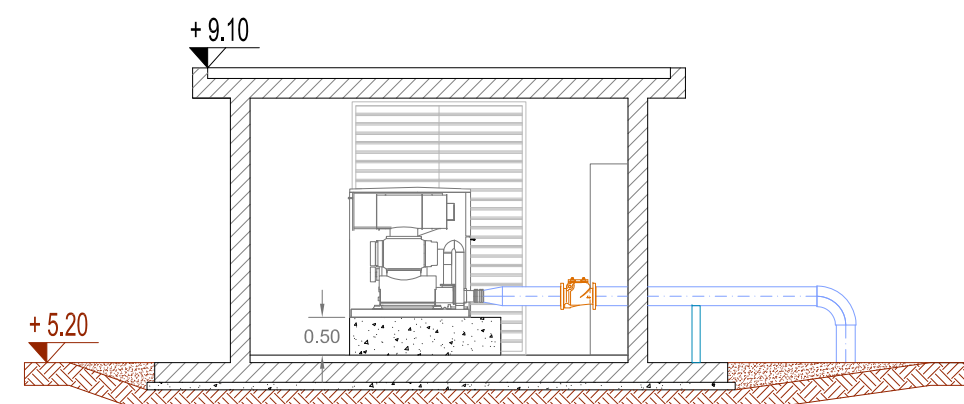

LEGENDA FLUSSI

LINEA ARIA COMPRESSA

LEGENDA GENERALE

Terreno

QUOTE ALTIMETRICHE

+ 5.20 Piano campagna

+ 9.10 Opere civili

PROSPETTO NORD

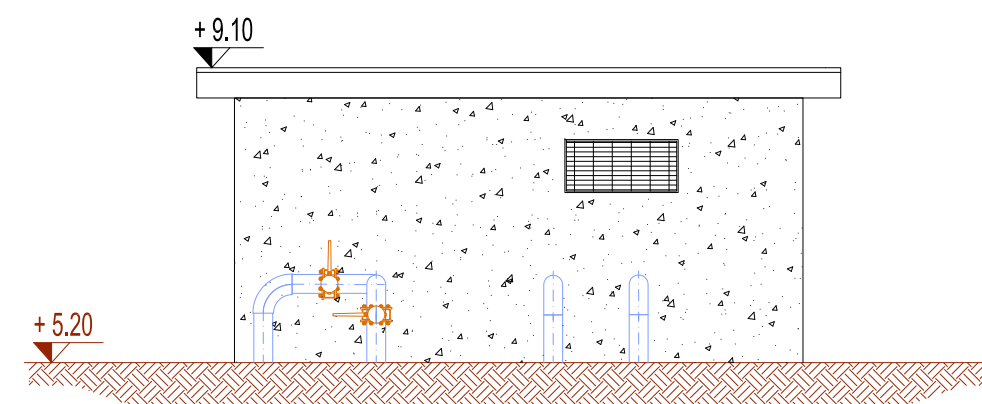

Regione Marche



Provincia di Pesaro Urbino

AMPLIAMENTO E MANUTENZIONE STRAORDINARIA DELL'IMPIANTO DI DEPURAZIONE DI MAROTTA - COMUNE DI MONDOLFO (PU)

PROGETTO DEFINITIVO

elaborato	titolo elaborato	scale
D-A.11	Locale compressori e quadri elettrici Stato di Fatto: Piante, sezioni e prospetto	1:100
consegna		
Aprile 2016		

Committente:



Azienda Servizi sul Territorio S.p.A.

via Enrico Mattei, 17 - 60132 Fano (PU)
tel: 071 83391
aset@asetservizi.it

Responsabile del Procedimento - Ing. Marco Romei

I progettisti:

Ingegneria INGENGERIA AMBIENTE S.r.l.
Ambiente Via del Consorzio, 39 - 60015 Falconara Marittima (AN)
S.r.l. tel. 071-9162094 - fax. 071-9189580
e_mail: info@ingegneriaambiente.it

Ing. Enrico Maria BATTISTONI - Direttore Tecnico

Ing. Lorenzo BURZACCA